



TUFF Y ELECTRIC HANDY CUTTER

MODEL 503K-2" CUTTER PARTS LISTS

Since 1888
CONSEW®

DRIVING MECHANISM

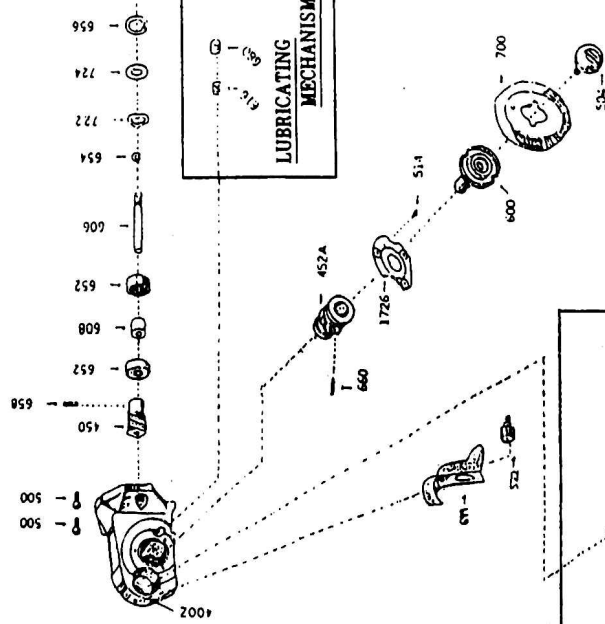

LUBRICATING MECHANISM

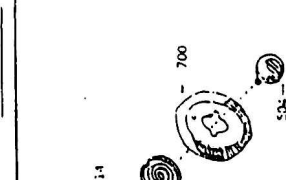

MOTOR PARTS

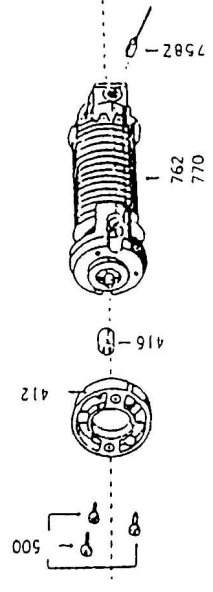

HOLDER & ITS ACCESSORIES

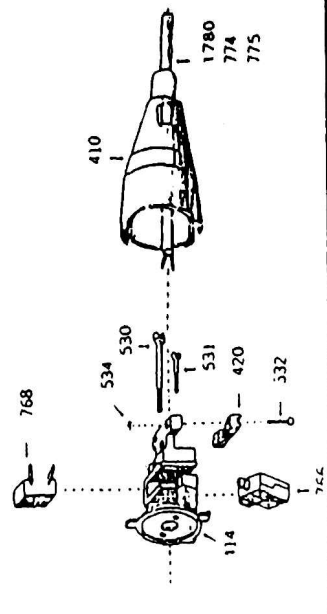

MICRON SYSTEM FEET

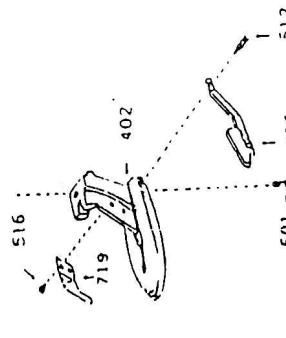

KNIVES

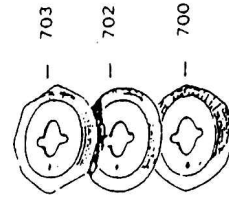

FRAME & SWITCH

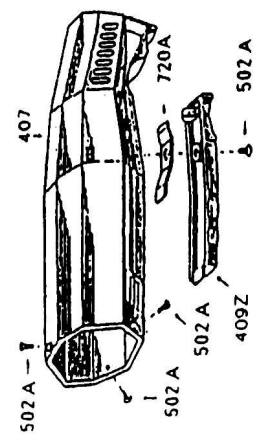

DRIVING MECHANISM

- 400Z Gear Housing
- 450 Worm
- 462A Worm Wheel
- 500 Allen Screw
- 504 Knife Lock Screw
- 514 Filister Head Screw
- 522 Screw for Knife Guard
- 600 Stepped Shaft
- 605 Shaft
- 608 Spacer
- 652 Ball Bearing
- 654 E Ring
- 656 Soap Ring

SHARPENING MECHANISM

- 508 Stepped Screw
- 510 Flat Head Screw
- 528 Push Button
- 602 Stepped Shaft
- 620 Spring

LUBRICATING MECHANISM

- 658 Sharpening Stone-Medium
- 660 Spring Pin
- 699 Knife Guard
- 700 6 Sided Knife
- 722 Undulated Washer
- 724 Washer
- 1726 Cover Plate

MICRON SYSTEM FEET

- 402 Base
- 501 Flat Head Screw
- 512 Screw for Base
- 516 Truss Head Screw
- 705 Cutting Tip(base)
- 719 Spring Plate

MOTOR PARTS

- 412 Insulator
- 416 Coupling
- 500 Allen Screw
- 758Z Carbon Brush Complete
- 762 Motor(110V)Complete
- 770 Motor(220V)Complete

KNIVES(Standard)

- 700 6 Sided Knife (Mounted with Cutter)
- 702 Round Knife (Included as Accessories)
- 703 8 Sided Knife (Option as Extra Accessories)

FRAME & SWITCH

- 531 Round Head Screw
- 532 Round Head Screw
- 534 Nut
- 1780 Cord(110V) 2pin
- 774 Cord(220V) 3wire
- 766 Micro Switch
- 768 Condenser

HOLDER & ITS ACCESSORIES

- 410 Cord Cover
- 414 Holder
- 420 Crtp
- 530 Flat Head Screw

FRAME & SWITCH

- 407 Frame
- 462Z Switch Cover
- 502A Socket Screw
- 720A Spring Plate

SHARPENING MECHANISM

